





# TABLE OF CONTENTS



- Pioneering Merit Badge Requirements..... 4
- Pioneering Knot List..... 5
- Rope Care and Safety..... 6
- Sail Maker's Whipping..... 9
- English Whipping..... 9
- Knot Tying Terms..... 10
- What Kind of Knot is it?..... 10
- Knots..... 11
- Bends..... 11
- Double Sheet Bend..... 11
- Carrick Bend..... 11
- Fisherman's Knot..... 12
- Water Knot..... 12
- Sheepshank..... 12
- Hitches..... 13
- Rolling Hitch..... 13
- Pipe Hitch..... 13
- Round Turn & Two Half Hitches..... 14
- Scaffold Hitch..... 14
- Barrel Hitch..... 15
- Constrictor..... 15
- Loop Knots..... 16
- Jug Knot..... 16
- Bowline on a Bight..... 17
- Butterfly Knot..... 17
- Masthead Knot..... 18
- Prussic Knot..... 19
- Cat's Paw..... 19
- Honda Knot..... 19
- Rope Tackle..... 20
- Lashings..... 21
- Gin Tripod Lashing..... 21
- West Country Shear Lashing..... 21
- Japanese Square Lashing..... 22
- Filipino Diagonal Lashing..... 23
- Trestle..... 24
- Pioneering Anchors..... 25
- Monkey's Fist..... 26
- Coiling Rope..... 26
- Grommet..... 26
- Turks Head Neckerchief Slide..... 27

## Shoe Lacings

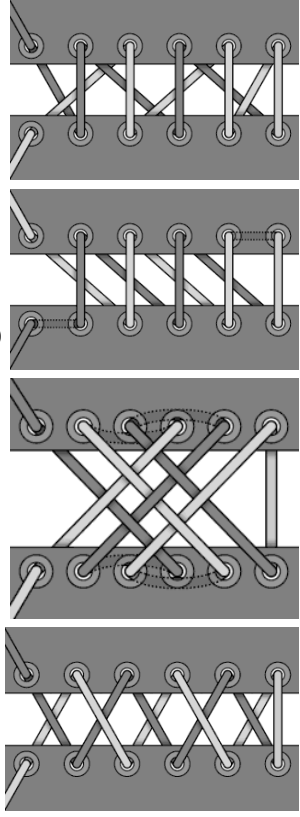

## The 'IAN' Shoelace Knot

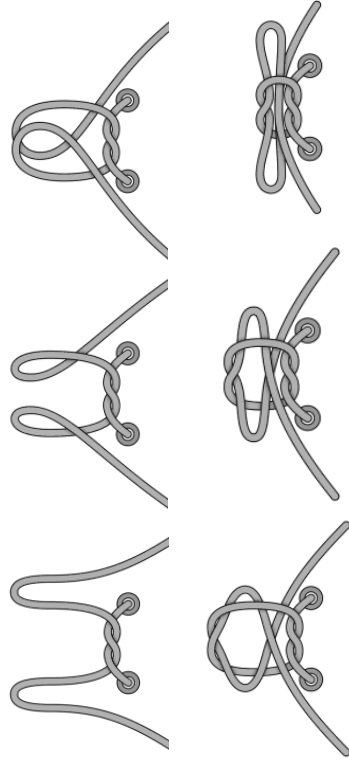

## Escher Towers

### Signal Tower

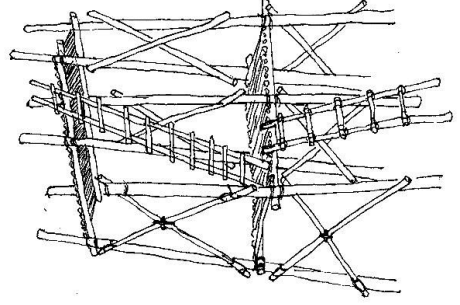

### Continuous Walkway Tower

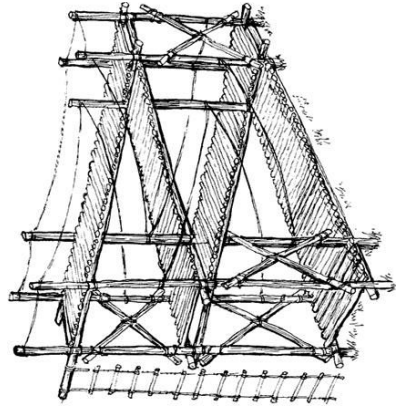

# SIGNAL TOWER

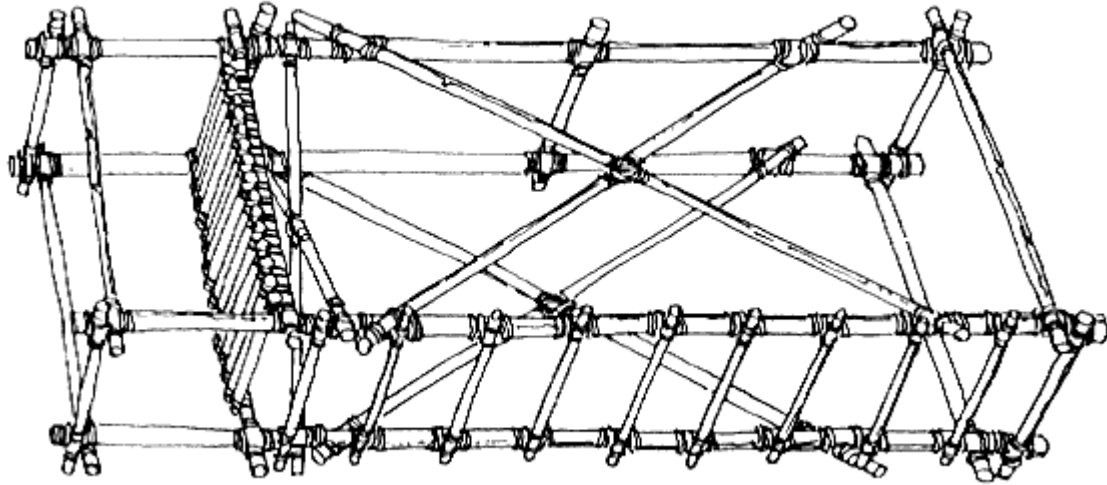

The greatest blunders, like the thickest ropes, are often compounded of a multitude of strands. Take the rope apart, separate it into the small threads that compose it, and you can break them one by one. You think, "That is all there was!" But twist them all together and you have something tremendous.

**VICTOR HUGO**

Eye Splice.....28  
 Back Splice.....29  
 Short Splice.....30  
 Ten Minute Tower.....31  
 Brynbach Tower.....32  
 Bridges.....33  
 Signal Tower.....34  
 Shoe Lacings.....35  
 The 'IAN' Shoelace Knot.....35  
 Escher Towers.....35  
 About This Booklet.....36



*Baden-Powell,  
 founder of  
 scouting  
 movement  
 oversees a  
 pioneering project*

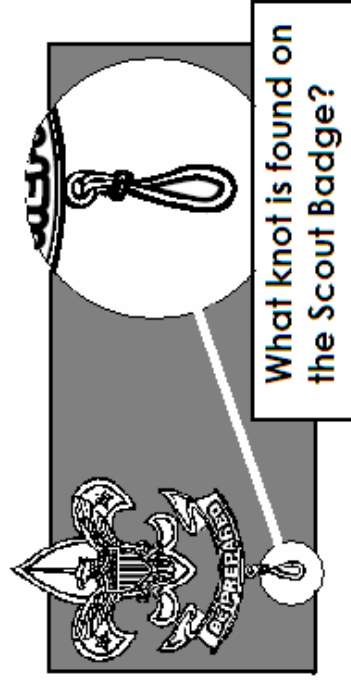

O time, thou must untangle this, not I.  
 It is too hard a knot for me to untie.

**WILLIAM SHAKESPEARE**

## Pioneering Merit Badge Requirements

1. Show that you know first aid for injuries or illness that could occur while working on pioneering projects, including minor cuts and abrasions, bruises, rope burns, blisters, splinters, sprains, heat and cold reactions, dehydration, and insect bites or stings.
2. Do the following:
  - a. Successfully complete Tenderfoot requirements [4a and 4b](#) and First Class requirements [7a, 7b, and 7c](#). (These are the rope-related requirements.)
  - b. Tie the following: square knot, bowline, sheepshank, sheet bend, and roundturn with two half hitches.
  - c. Demonstrate the following: tripod and round lashings.
3. Explain why it is useful to be able to throw a rope, then demonstrate how to coil and throw a 40-foot length of 1/4- or 3/8-inch rope. Explain how to improve your throwing distance by adding weight to the end of your rope.
4. Explain the differences between synthetic ropes and natural-fiber ropes. Discuss which types of rope are suitable for pioneering work and why. Include the following in your discussion: breaking strength, safe working loads, and the care and storage of rope.
5. Explain the uses for the back splice, eye splice, and short splice. Using 1/4- or 3/8-inch three-stranded rope, demonstrate how to form each splice.
6. Using a rope-making device or machine, make a rope at least 6 feet long consisting of three strands, each having three yarns.
7. Build a scale model of a signal tower or a monkey bridge. Correctly anchor the model using either the 1-1-1 anchoring system or the log and stake anchoring method. Describe the design of your project and explain how the anchoring system works.
8. Demonstrate the use of rope tackle to lift a weight of 25 pounds and pulling a log at least 6 inches in diameter and 6 feet long with the tackle. Use the tackle to put tension on a line. Explain the advantages and limitations of using a rope tackle. In your explanation, describe the potential damage that friction can do to a rope.
9. By yourself, build an A-trestle OR X-trestle OR H-trestle using square and diagonal lashings. Explain the application of the trestle you build. Demonstrate how to tie two spars together using a shear lashing.
10. With a group of Scouts, OR on your own, select a pioneering project. With your counselor's guidance, create a rough sketch of the project. Make a list of the ropes and spars needed, then build the project. (Note: This requirement may be done at summer camp, at district or council events, or on a troop camp outing.)

## BRIDGES

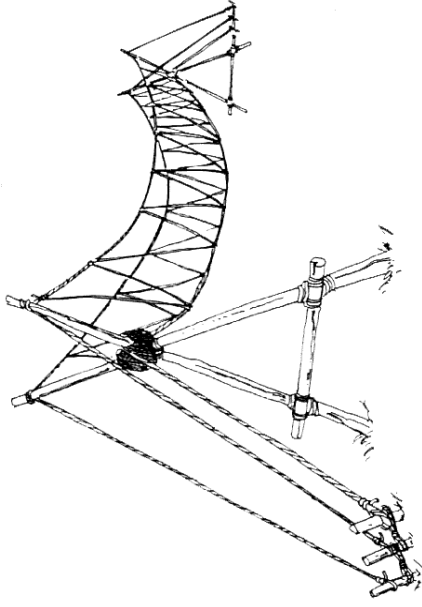

Monkey Bridge

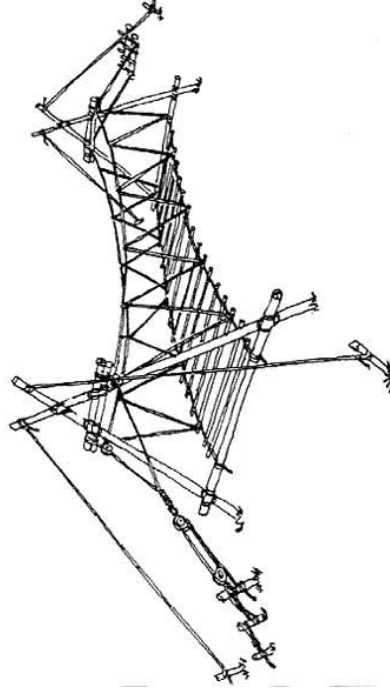

Suspension Bridge

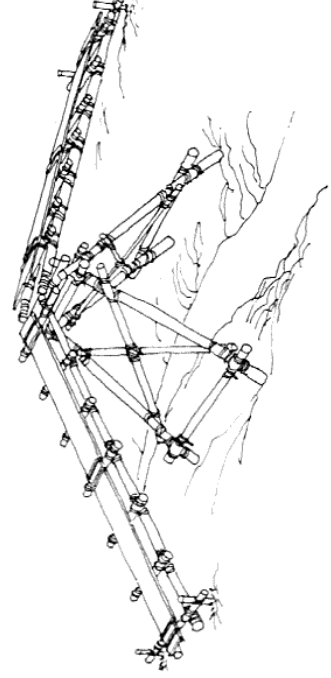

Double Lock Bridge

# BRYNBACH TOWER

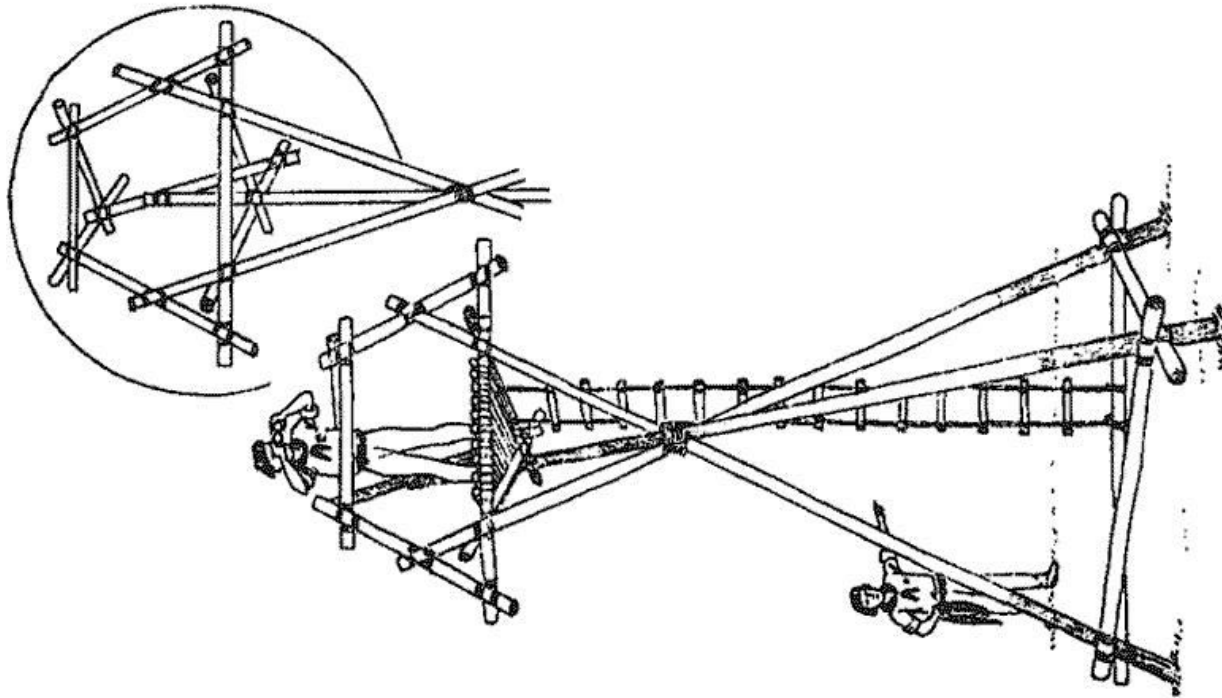

## Pioneering Knot List

| Knot or Lashing                       | Rank/ Handbook Page        | Notes                         |
|---------------------------------------|----------------------------|-------------------------------|
| Square Knot                           | Scout Rank P. 8            | Basic Knots For Pioneering MB |
| Clove Hitch                           | 1st Class 7B – P. 139      |                               |
| Timber Hitch                          | 1st Class 7B – P. 138      |                               |
| Bowline                               | 1st Class 8A – P. 149      |                               |
| Sheet Bend                            | 1st Class 8A – P. 160      |                               |
| Sheep Shank                           |                            |                               |
| Round Turn & 2 Half Hitches           |                            |                               |
| Whip & Fuse Rope                      | Tenderfoot Rank 4A – P. 34 |                               |
| Two Half Hitches                      | Tenderfoot Rank 4B – P. 36 |                               |
| Taut-Line Hitch                       | Tenderfoot Rank 4B – P. 36 |                               |
| Square Lashing                        | 1st Class 8A – P. 141      |                               |
| Shear Lashing                         | 1st Class 8A – P. 142      |                               |
| Diagonal Lashing                      | 1st Class 8A – P. 143      |                               |
| <b>Pioneering MB Additional Knots</b> |                            |                               |
| Double Sheet Bend                     | Honda                      |                               |
| Carrick Bend                          | Prussic                    |                               |
| Rolling Hitch                         | Cat's Paw                  |                               |
| Pipe Hitch                            | Rope Tackle                |                               |
| Barrel Hitch                          | Fisherman's Knot           |                               |
| Constrictor                           | WC Shear Lashing           |                               |
| Bowline on a Bight                    | Butterfly Knot             |                               |
| Water Knot                            | Masthead Knot              |                               |

## Rope Care and Safety

**SELECT BEST ROPE FOR THE JOB.** Choose the right material, size and strength.

**STORE ROPE PROPERLY.** Rope should be dry, untied, properly coiled after use.

**KEEP ROPE CLEAN.** Dragging rope on the ground or floor causes abrasive dirt to weaken the rope fibers.

**KINKS CAUSE ROPE FAILURE.** Kinks cause damage. Straighten them by twisting, not pulling.

**AVOID SUDDEN STRAINS.** Jerks may break a rope normally strong enough to handle the load safely. A steady, even pull assures full strength from rope.

**DOUBLE CHECK** all poles, ropes, knots, lashings, anchors etc. before using any pioneering structure.

## NEVER NEVER NEVER

- Wrap rope around any part of the body except for demonstrating or using proper knots.
- Trust your weight to a rope of unknown strength or condition
- Use a rope as a whip



## TEN MINUTE TOWER

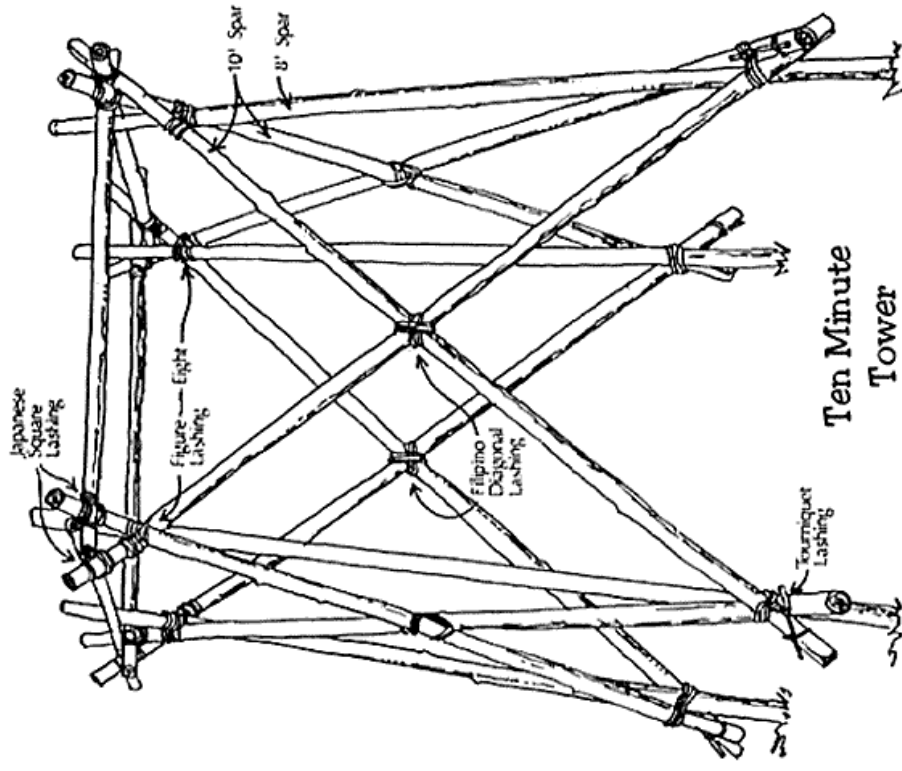

Ten Minute Tower

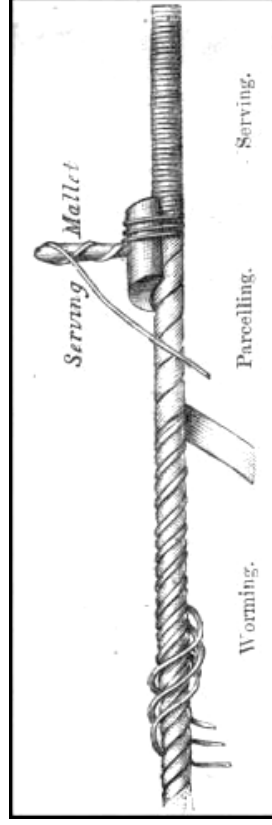

## SHORT SPLICE

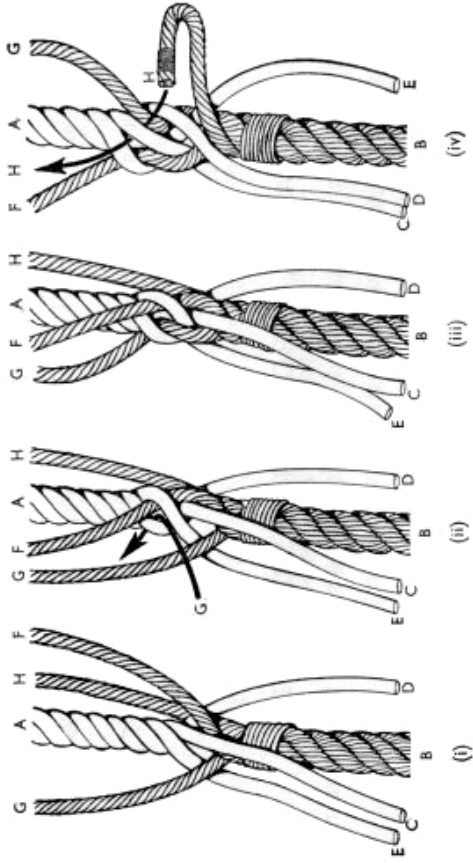

(I) Unlay the lay of both ropes for several times the rope diameter. A temporary whipping one will prevent unraveling. Marry the strands together alternating one from each end.

(II) Tuck F under E and G under D

(III) First two tucks completed

(IV) Rotate the splice 180 degrees and tuck H under C. This completes the first set of tucks.

Continue tucking F, G and H over one lay and under the next. Remove the temporary whipping and tuck C, D and E over one strand and under the next. Tuck each lay three times

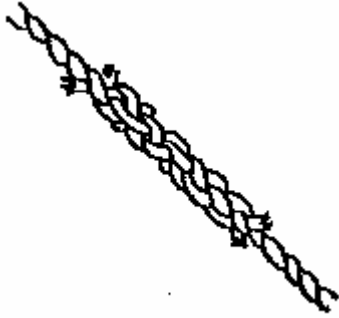

## Rope Materials, Characteristics and Use

### Laid Rope

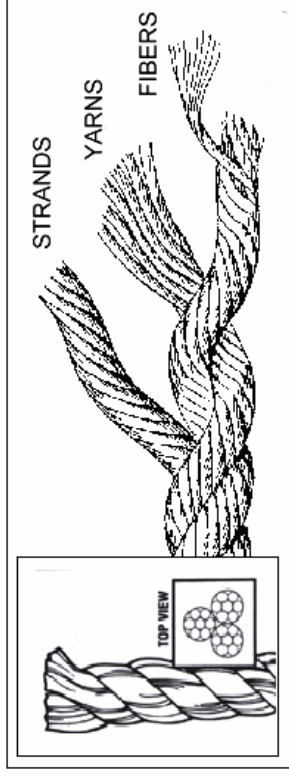

Laid rope is made up of fibers twisted into yarns that are twisted into strands and laid into a rope.

### Braided Or Woven Rope

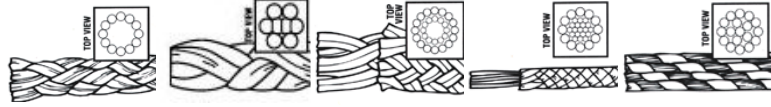

**Twelve-Strand Braided Ropes:** 12 strands are braided over and under each other in a maypole fashion to create a hollow, tubular structure.

**Plaited Ropes:** Eight strand plaited rope formed by intertwining four pairs of strands in a maypole fashion with two pairs moving clockwise and two pairs moving counter-clockwise.

**Double Braided Ropes:** Two ropes in one, a braided core is over-braided with a cover braid, hence the terms braid on braid and 2 in 1 braid.

**Hollow & Diamond Braids:** A hollow, tubular structure braided in a maypole fashion to produce a plain braid pattern with and without a core

**Solid Braids:** The strands are intertwined by braiding in a circular pattern to form a solid tubular structure.

# BACK SPLICE

| Natural Fibers          | Cost   | Stretch | Sunlight Resistance | Rot Resistance | Workability | Strength | Durability | Pioneering Uses |         |        |                   |
|-------------------------|--------|---------|---------------------|----------------|-------------|----------|------------|-----------------|---------|--------|-------------------|
|                         |        |         |                     |                |             |          |            | Knitting        | Lashing | Tackle | Anchor - Footrope |
| Manila                  | \$\$   | +       | G                   | G              | E           | G        | G          | X               | X       | X      | X                 |
| Sisal                   | \$     | ++      | G                   | P              | G           | F        | F          | X               | X       |        |                   |
| Cotton                  | \$     |         | G                   | P              | G           | F        | G          |                 |         |        |                   |
| <b>Synthetic Fibers</b> |        |         |                     |                |             |          |            |                 |         |        |                   |
| Polypropylene           | \$\$   | +       | P                   | E              | F           | G        | G          |                 |         |        | X                 |
| Polyethylene            | \$     | +       | F                   | E              |             |          |            |                 |         |        |                   |
| Polyester               | \$\$\$ | -       | E                   | E              | G           | E        | E          | X               | X       | X      | X                 |
| Nylon                   | \$\$\$ | ++      | G                   | E              | E           | E        | E          | X               | X       | X      | X                 |

**Manila** Perhaps the best overall rope. It has a good size to strength ratio, does not stretch too much and handles well when tying knots and lashings. While it can withstand frequent wetting and drying it must be stored dry to avoid mildew and rot.

**Sisal** Has a poor size to strength ratio, does not handle well and wears our quickly. While it is less expensive than manila it's limited use and durability make it a second choice for pioneering.

**Cotton** Braided or twisted cotton is outclassed in strength and durability by just about all other ropes. It is suitable for clotheslines and hammocks but not for pioneering or camping.

**Polypropylene** Has an excellent strength to size ratio, handles well but weakens with long exposure to sunlight.

**Nylon** The stretch factor in nylon rope makes it difficult to work with when lashing. An excellent size to strength ratio and durability make it a good rope for general use.

**Polyester** Most braided climbing ropes are polyester. It handles well, has an excellent weight to strength ratio and limited stretch factor. It is much more expensive than manila or nylon ropes and has limited use in pioneering.

**Polyethylene** The least expensive of the synthetic fiber ropes. It's stiffness and poor handling qualities make it undesirable for pioneering.

**Binder Twine** Loosely twisted jute fibers treated with oil. It serves as a lightweight cord for throw-away uses such as lashing small diameter poles or staves for camp gadgets. Binder twine is used to demonstrate rope making and can serve as a reasonably good fire starter

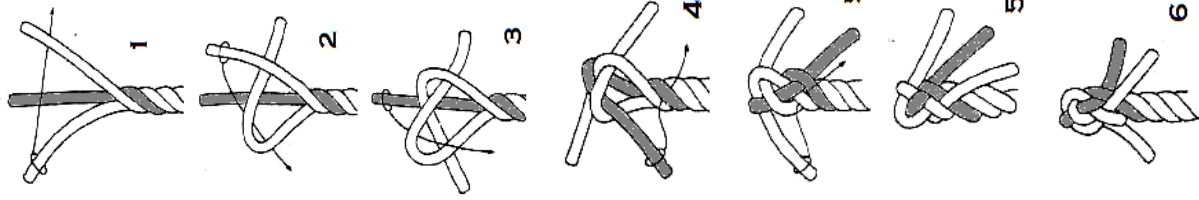

1. Unlay the rope 5 or 6 turns

2-3 Form crown knot as shown. From above it should look like this:



4. Tuck one lay over the adjoining end and under itself.

5. Tuck the next strand over and under

6 Tuck the remaining strand over and under.

To finish the back splice continue tucking each lay over and under several times.



The finished splice

## EYE SPLICE

- (1)&(2) Count back and unlay 5 rounds of the lay of the rope.
- 3) Fan the unlay end of the rope and place it over the standing part of the rope. The strand to the inside of the eye must look like it is coming out from under the other two strands and the other two strands must be fanned in such a way that they do not cross each other.

- (4) While holding the inside strand in place, stick the middle strand under one of the strands of the standing end of the rope.
- (5) Pass the inside strand over the standing end strand and stick it under the next standing end strand.
- NOTE:** The second strand goes in where the first strand came out. (6) Turn the splice over.

- (7) Stick the third strand under the remaining strand of the standing end.
- NOTE:** The third strand is stuck in where the second strand came out and comes out where the first strand went in. [**NOTE**] When the third strand is stuck it appears to go backward but when it is examined closely you will see that it is stuck in the same direction as the other two strands.

- (8B) & (8F) Complete the splice by working the strands snug and adding 3 to 5 50unds of tucks. **NOTE:** When the strands are folded back over the eye, you will notice that there is one strand going in and one strand coming out between each of the strands of the standing end

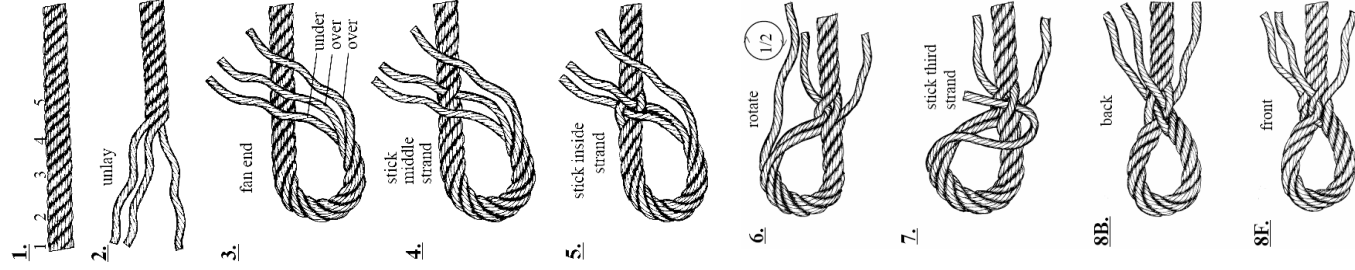

## Sail Maker's Whipping

1. Begin by unlaying (untwisting) the rope two inches. Make a bite in a 3-foot length of whipping thread and place it around one of the strands.
2. Re-lay the rope. Wind the whipping thread tightly around the rope end for a sufficient number of turns.
3. Carry the bight originally formed back over the end of the same strand around which it was laid.
4. Pull ends tight and tie them with a square knot between the rope ends. Trim ends of whipping thread.

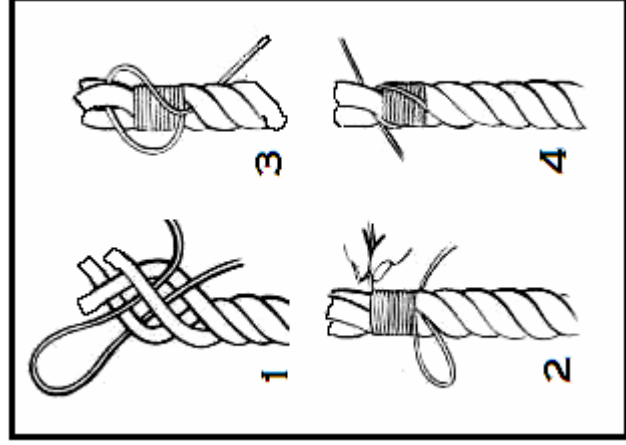

## English Whipping

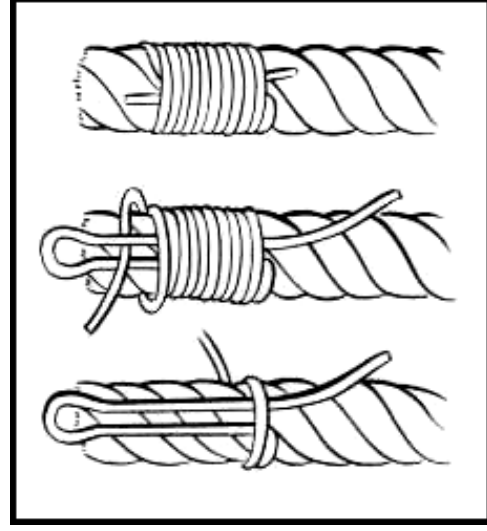

- Form a loop in whipping thread and lay it along the end. Wrap the whipping thread tightly around the rope. When the whipping is as wide as the rope is thick, slip the end through the loop, pull hard, and trim whipping thread.

## Knot Tying Terms

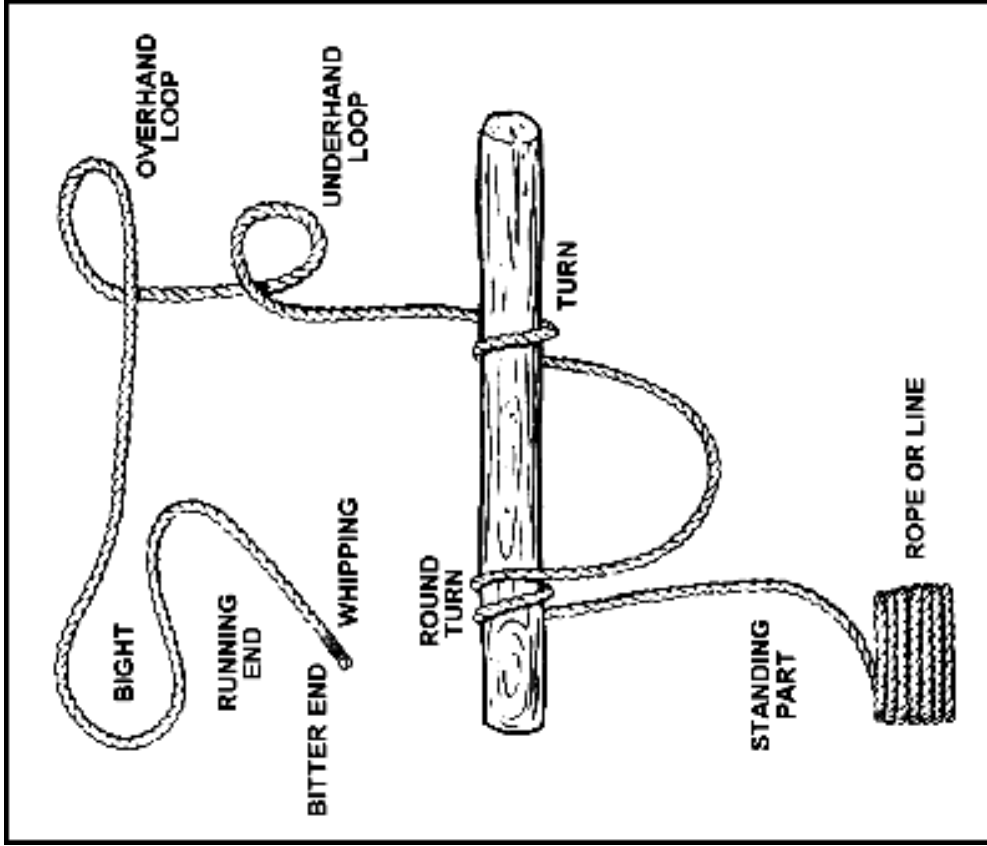

## What Kind of Knot is it?

**Bend**- joins two ropes together

**Hitch** – ties rope to a post, stake etc.

**Stopper** – usually on the end of a rope to prevent it being pulled through an opening

**Loop** – forms a single or multiple loop.

**Lashing** –binds objects together with multiple turns.

## TURKS HEAD NECKERCHIEF SLIDE

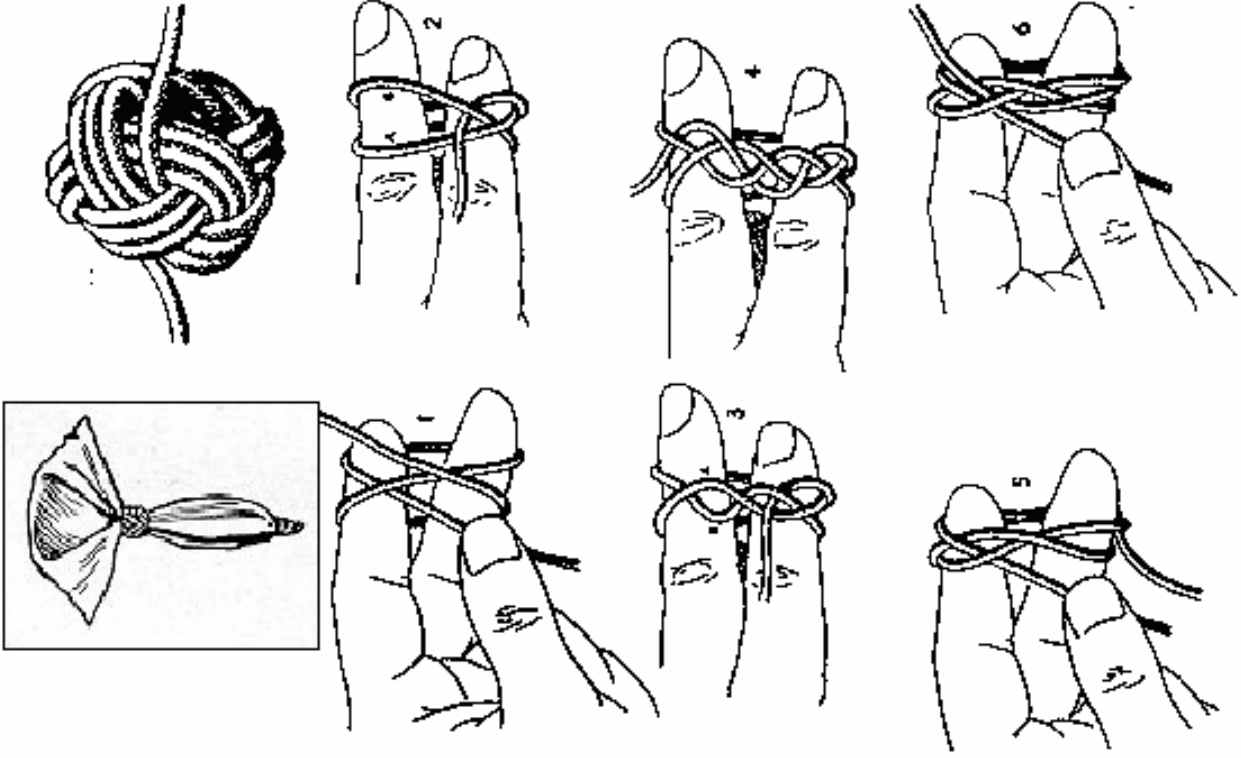

# MONKEY'S FIST

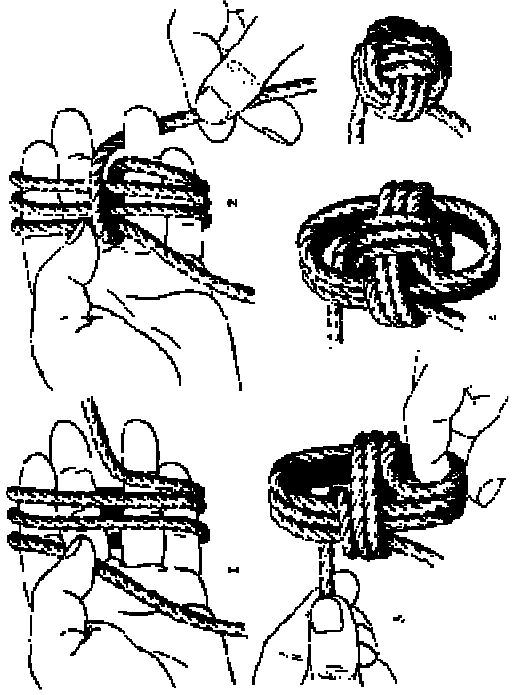

# COILING ROPE

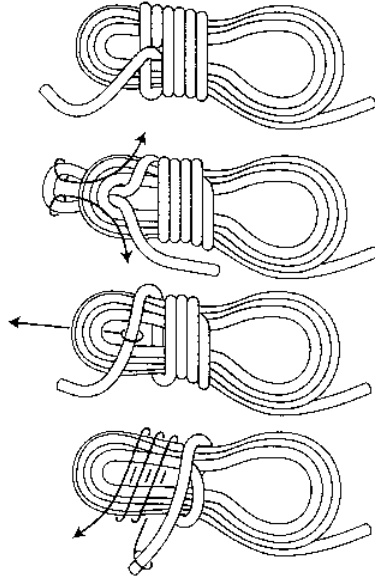

# GROMMET

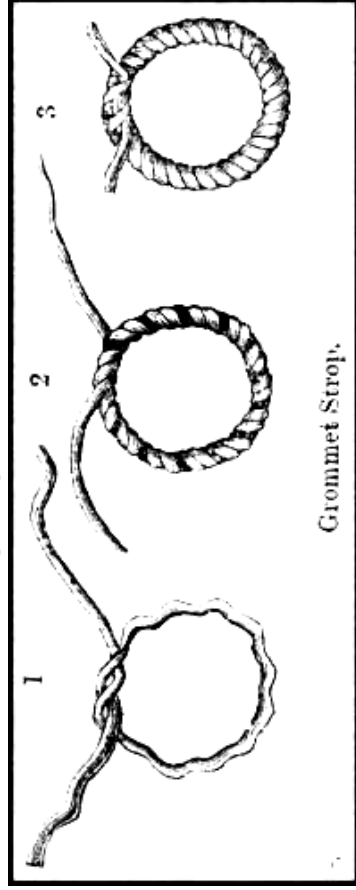

Grommet Strop.

# KNOTS

## BENDS

### Double Sheet Bend

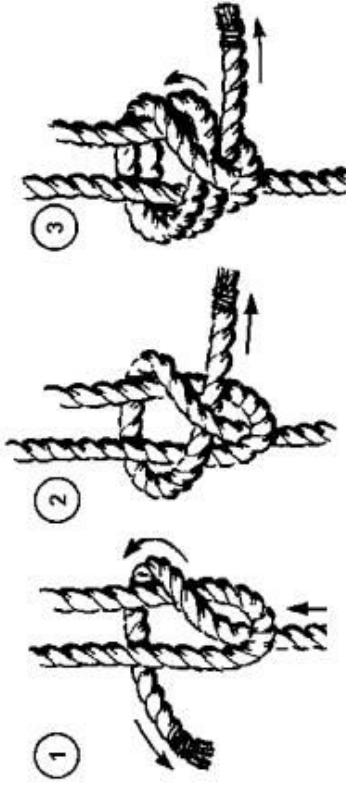

Used to join two ropes of different diameter.

### Carrick Bend



The first and almost always best way to join the ends of two ropes.

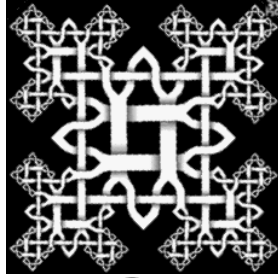
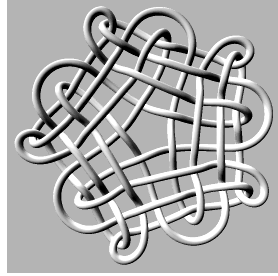

Computer generated knots

### Fisherman's Knot

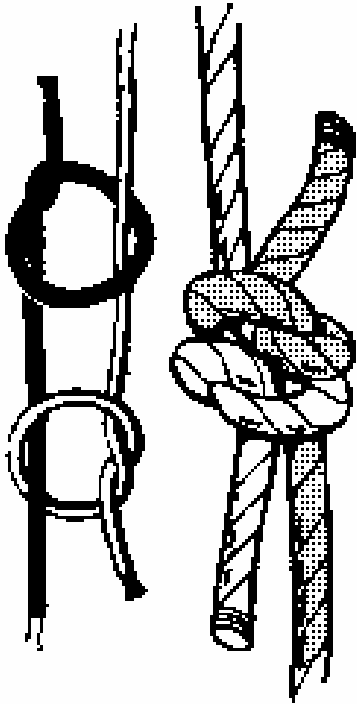

The Fisherman's knot is used to tie two ropes of equal thickness together. It is used by fishermen to join fishing line, and is very effective with small diameter strings and twines.

### Water Knot

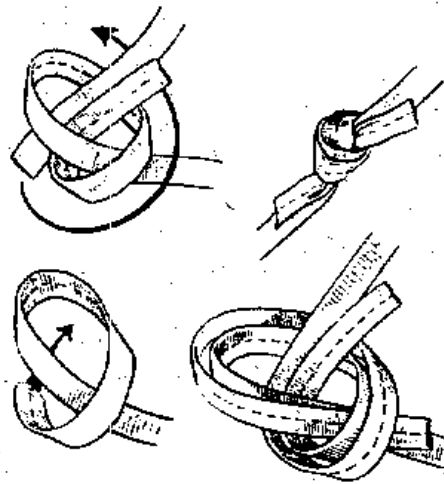

Shown here tied with webbing the water knot can be tied in rope as well. Use wherever a strong non-jamming knot is called for to join the ends of ropes.

### Sheepshank

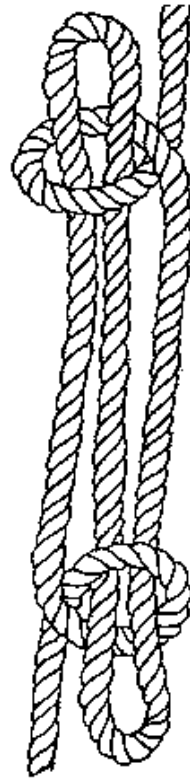

Used to shorten rope under tension.

## PIONEERING ANCHORS

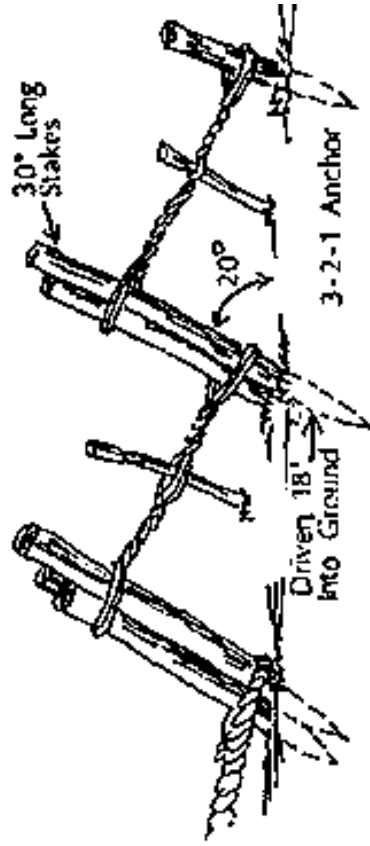
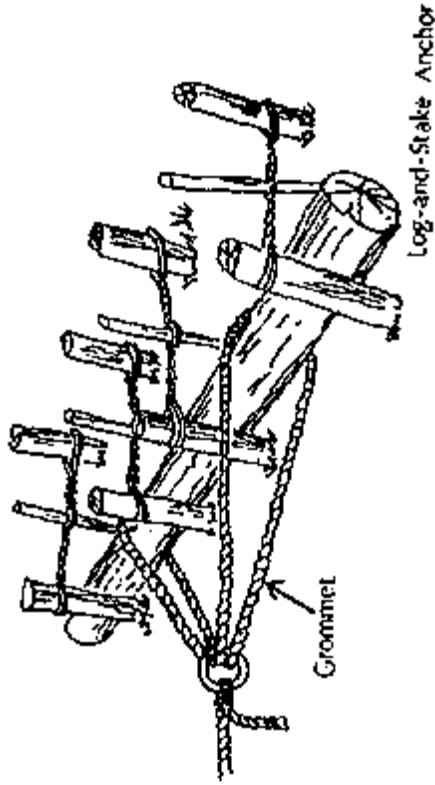
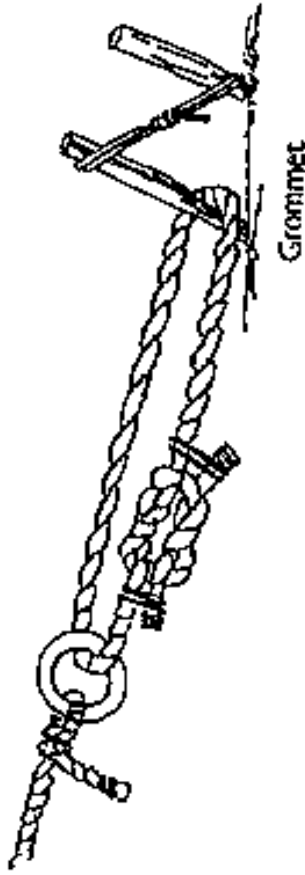

# TRESTLE

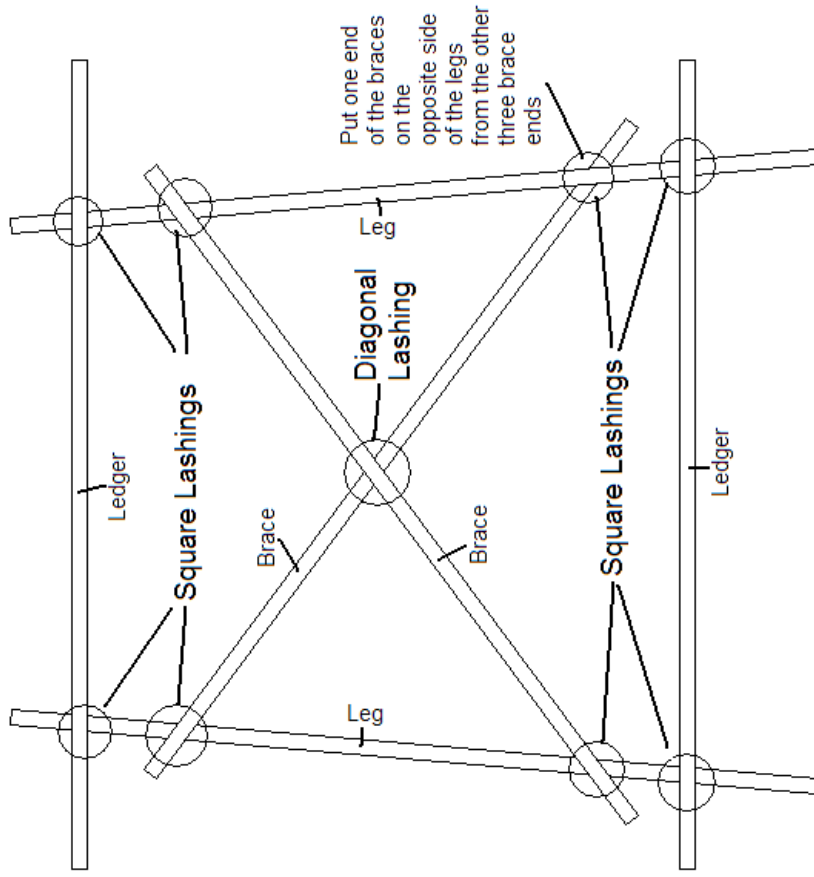

The trestle demonstrates pioneering construction techniques. Begin by lashing the ledgers to the legs and add the braces. The center diagonal lashing should be tied last. Bracing diagonally give the structure adding great strength and rigidity. This technique is called triangulation. Note that one end of the brace is opposite the other four ends to add locking tension to the brace.



# HITCHES

Rolling Hitch

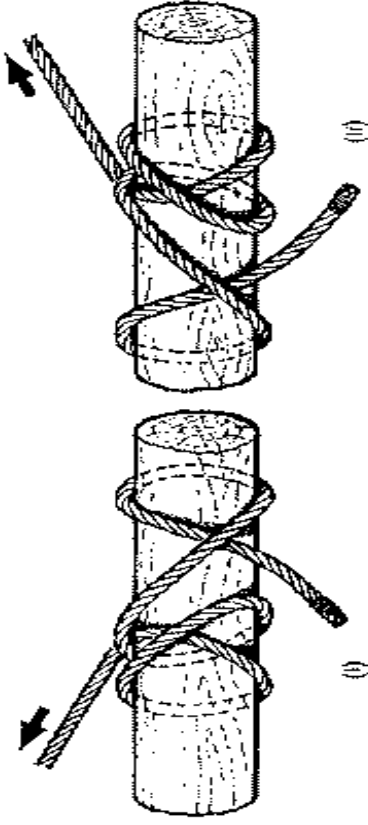

If you look at this hitch closely you see that it is really a clove hitch that ends with a turn. Best tied so that the load pulls against the hitch as shown.

Pipe Hitch

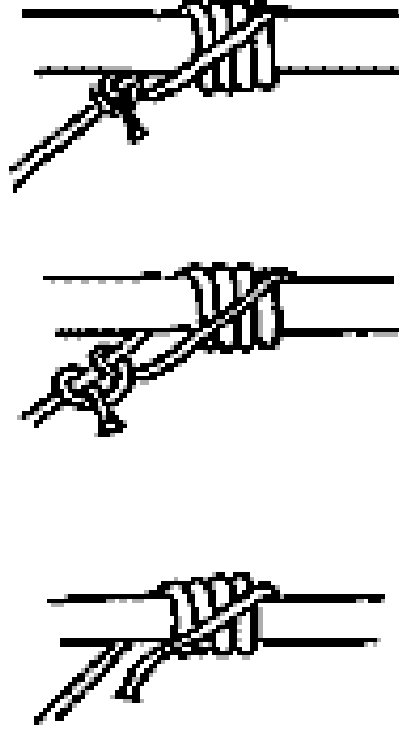

This hitch will not slip on pipes, poles or other round objects.

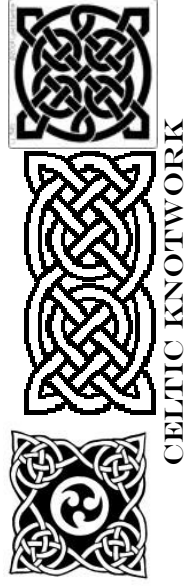

CELTIC KNOTWORK

## Filipino Diagonal Lashing

### FILIPINO DIAGONAL LASHING

THIS IS ANOTHER LASHING WHICH REQUIRES ONLY ONE KNOT - A REEF AT THE END. REMEMBER TO PULL ALL LASHINGS TIGHT.

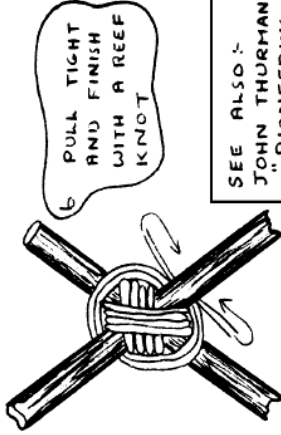
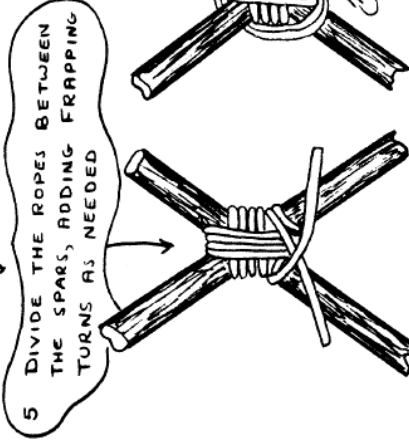
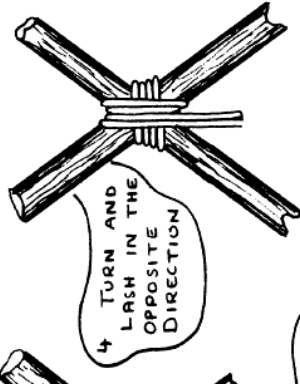
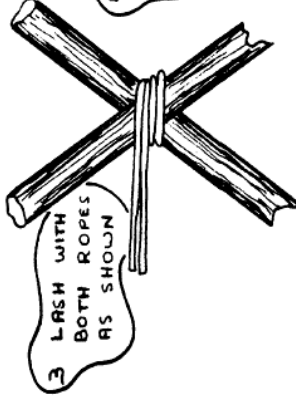
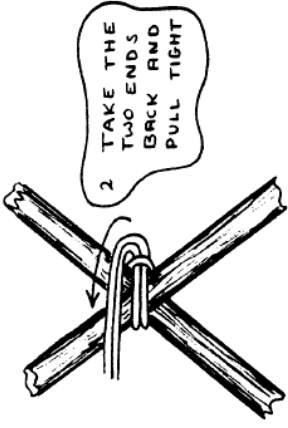
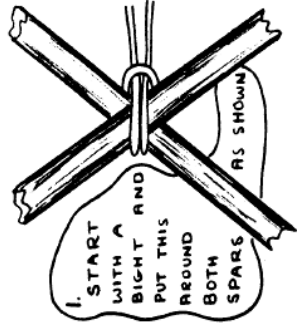

SEE ALSO: JOHN THURMAN'S "PIONEERING PRINCIPLES"

## Round Turn & Two Half Hitches

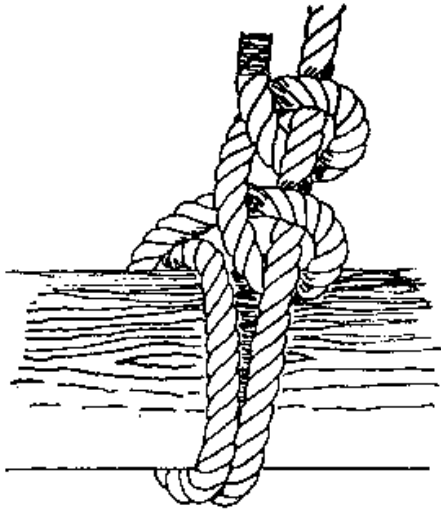

Provides a strong, non-jamming hitch. The additional turn is added before the two half hitches are tied.

## Scaffold Hitch

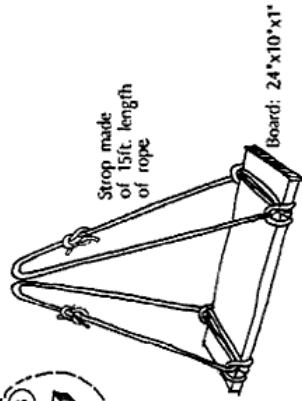
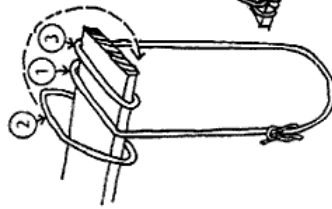
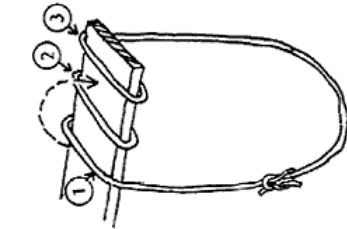

## Scaffold Hitch

The scaffold hitch is made with two loops or strops to form a bosun's chair. The chair can be used for overhead tramways or a work platform.

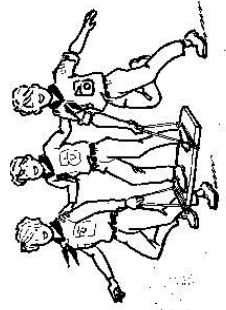

## Japanese Square Lashing

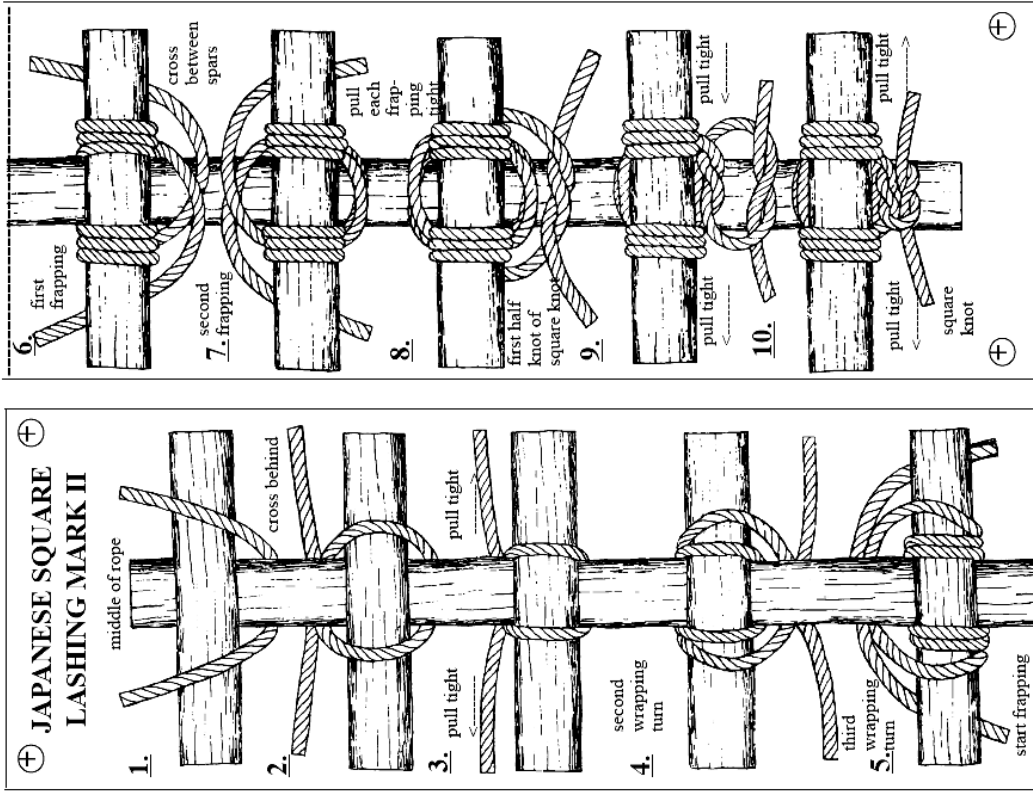
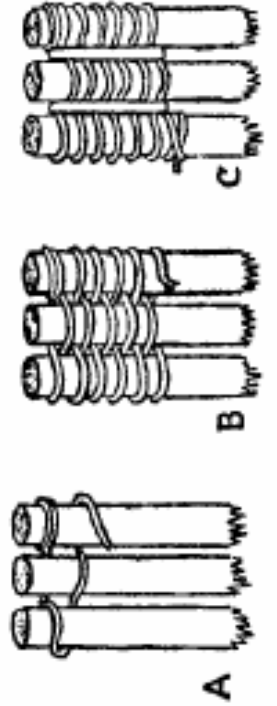
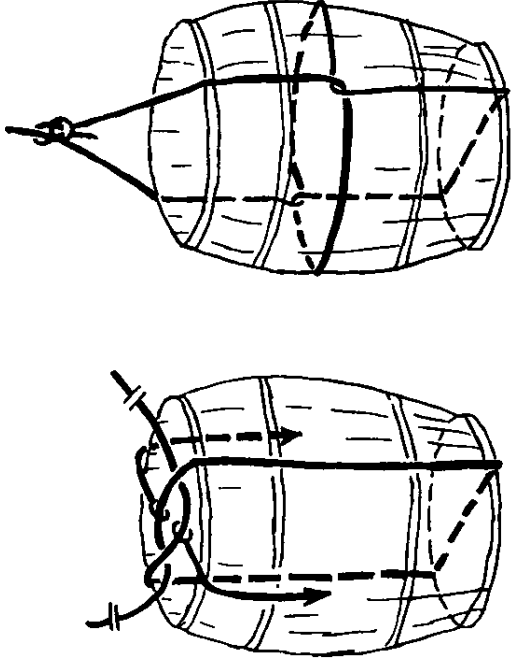

Figure of Eight Lashing



## Barrel Hitch



Provides a lifting sling for barrels or buckets. Two hitches will help stabilize the load.

## Constrictor

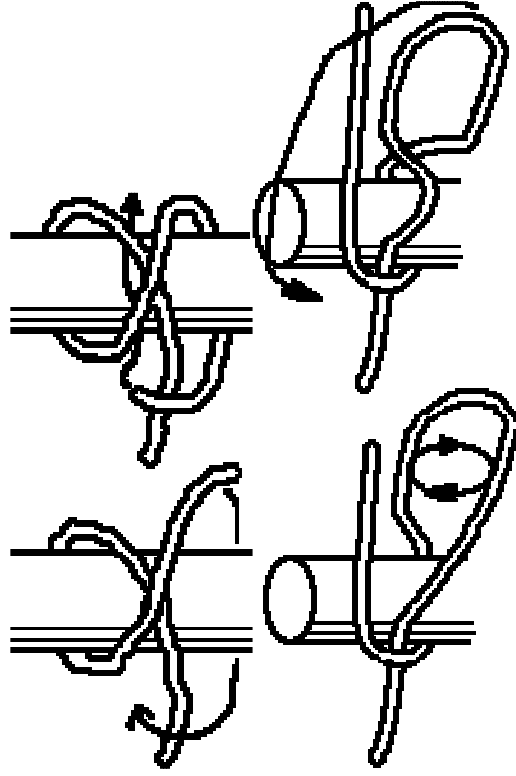

The constrictor knot is important as temporary whipping and as permanent binding. Never use it if you need to untie it. When you cannot place the knot around the object after the knot is formed, you have to tie it round the object. This may be difficult if you did not leave enough room to put the end through.

# LOOP KNOTS

## Jug Knot

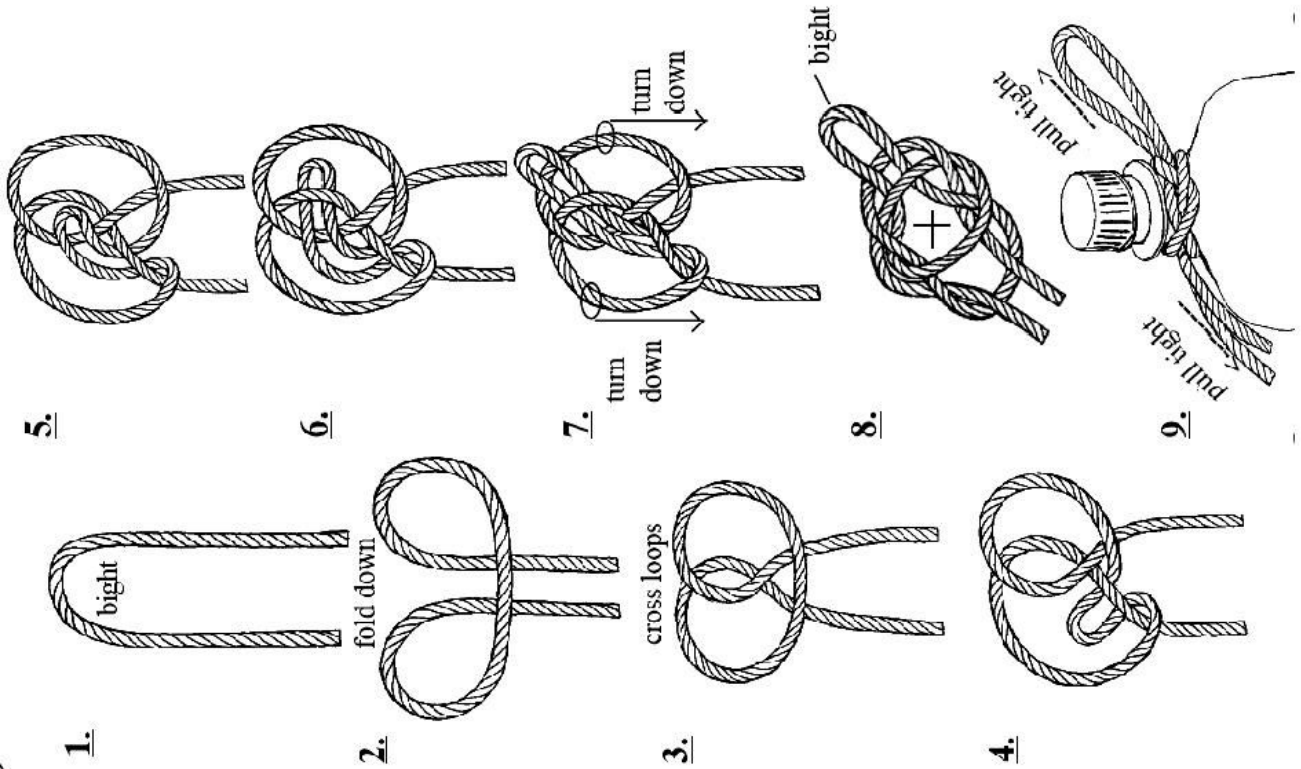

# LASHINGS

## Gin Tripod Lashing

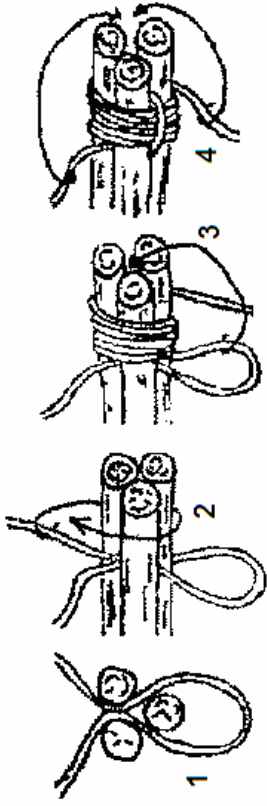

A quick, strong lashing for lightweight tripods.

1. Make a loop over one of the poles with the ends leading between the other two.
2. Lead the long end of the rope above the loop and wrap it around all three poles about five or six times. Put the loop over the wraps and over top of same pole.
3. Pull the loop tight with the short end of the rope. Lead the short end over the wraps in the between two poles opposite the loop.
4. Tie the ends of the rope together with a square knot between the ends of the poles.

## West Country Shear Lashing

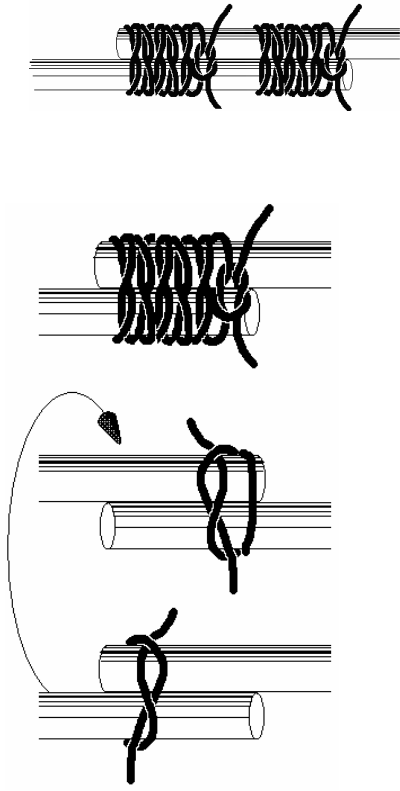

This lashing is a series of overhand knots made on alternating sides and finished with a Square Knot. Two lashings make a strong shear joint between two poles.

## Rope Tackle

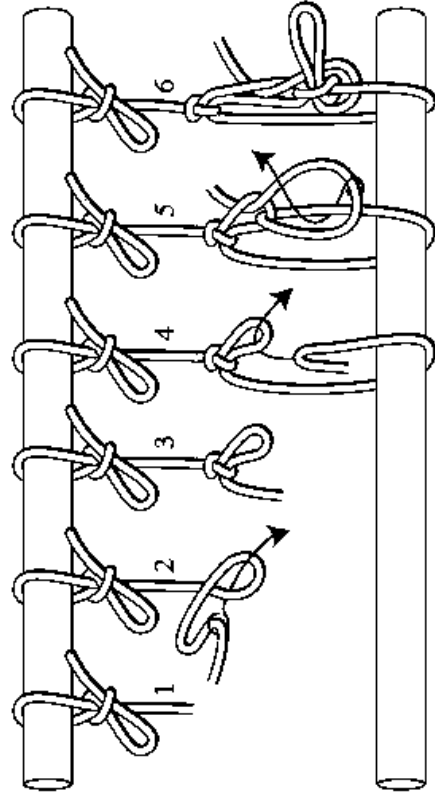
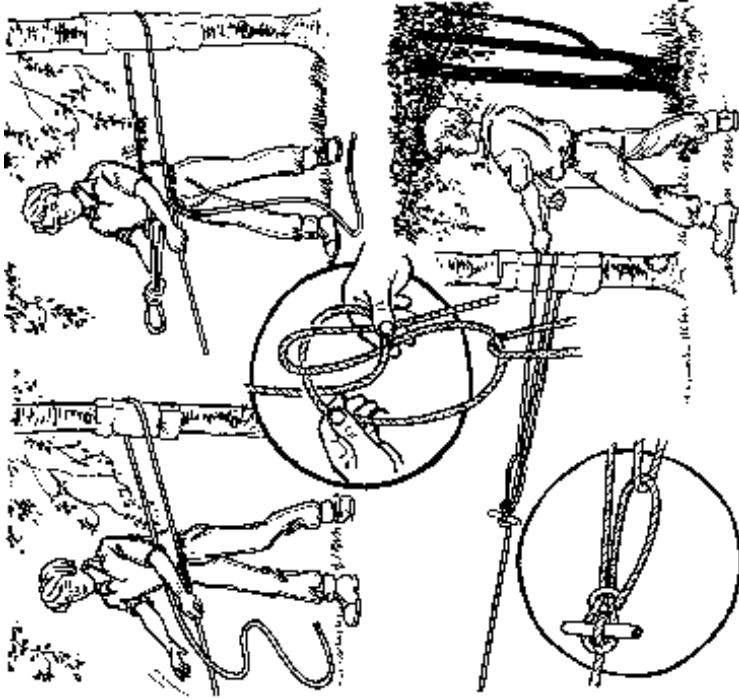

The rope tackle is used to tighten lines or lift loads. It is a simple, effective alternative to pulleys. The toggle or stick shown in the drawing prevents the loop from jamming.

## Bowline on a Bight

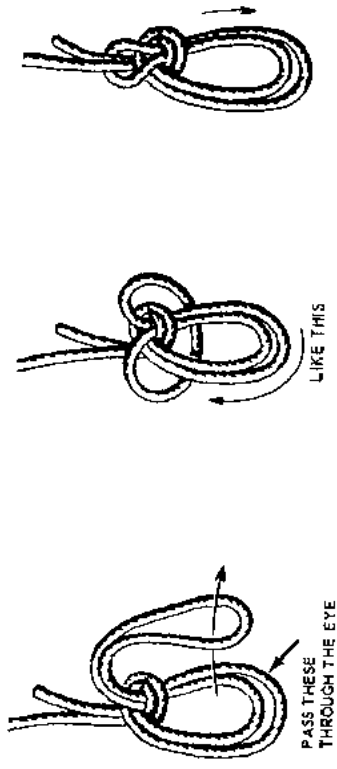

Forms two fixed loops and can be tied without access to the ends of the rope

## Butterfly Knot

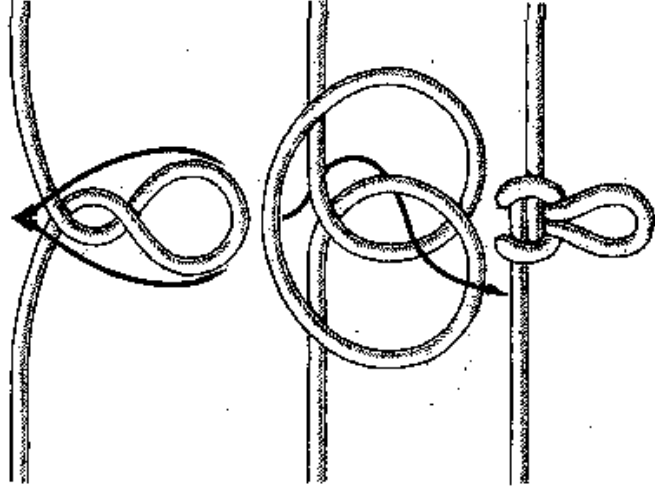

Forms a fixed loop without access to the ends of the rope

**Masthead Knot**

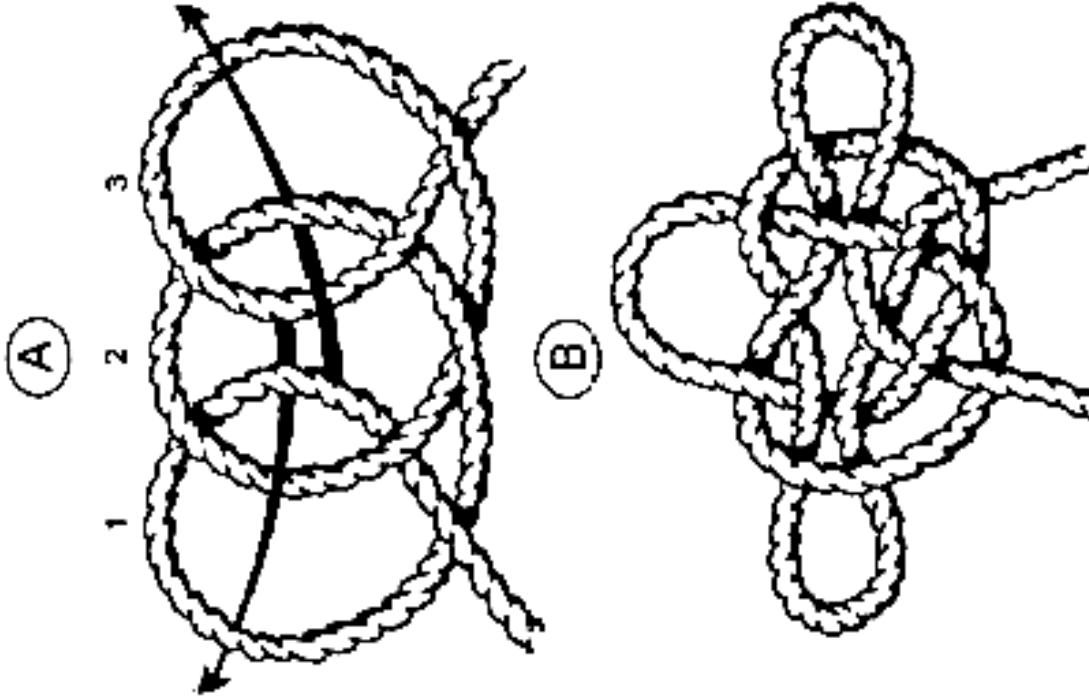

Placed on the top of a pole or mast this knot forms loops for guy lines to support the pole.



**Prussic Knot**

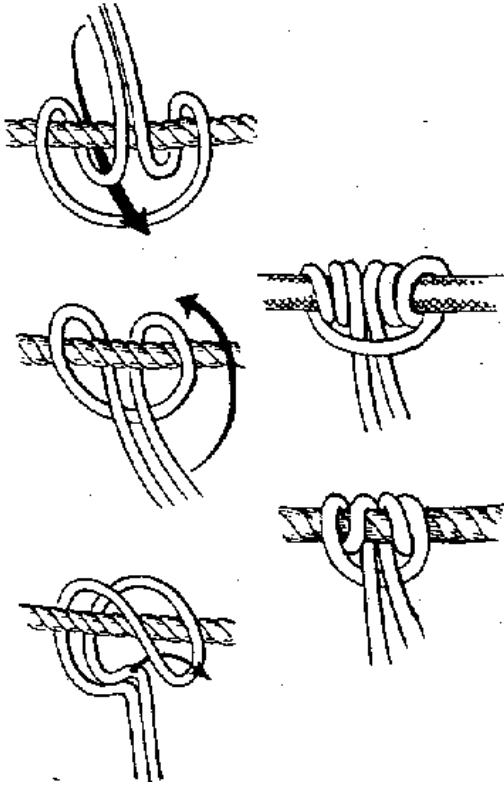

Forms a movable knot on another rope. Note that it can be doubled to gain more purchase on a smooth rope

**Cat's Paw**

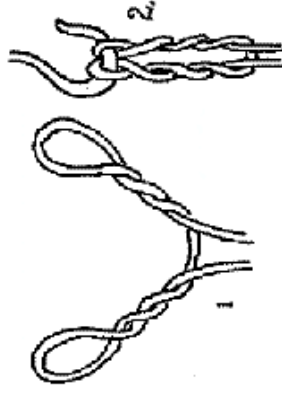

Secures a line to a hook for lifting loads.

**Honda Knot**

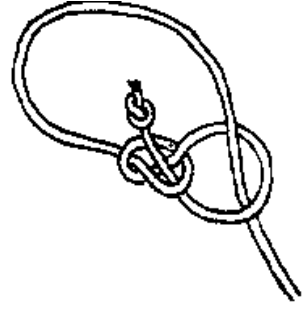

Forms a running loop or lasso.